

Gas Countertop Griddle Operating Instructions

**WARNING: THE EQUIPMENT MUST
INSTALLED BY A LICENSED
INSTALLER IN ACCORDANCE TO
AS/NZS 5601 STANDARD AND
REGULATION**

Before you begin, please read these instructions carefully to use this product correctly, to make the product perform ideally, and to avoid hazards.

**Models: AT65G4G-C
(INCLUDING NG AND LPG MODEL)**

Dear customers and users:

Thank you for purchasing our products. In order to be able to better use this product, please read these instructions carefully before any operation, and follow the guide, to avoid any unnecessary trouble during using.

Please keep this instruction manual in a safe place for convenient reference and operation.

This instruction manual is subject to any change without further notice, and the manufacturer reserves the right of final interpretation.

The appliance is designed for commercial purposes, not for household use.

DANGER

If you smell gas:

- Shut off gas to the appliance.
- Extinguish any open flame.
- If odor continues, keep away from the appliance and immediately call your gas supplier or your fire department.

FOR YOUR SAFETY

Do not store or use gasoline or other flammable vapors or liquids in the vicinity of this or any other appliance.

WARNING: Improper installation, adjustment, alteration, service or maintenance can cause property damage, injury or death. Read the installation, operating and maintenance instructions thoroughly before installing or servicing this equipment.

Gas Countertop Griddle

The Installation, Operation and Maintenance Guide

Contents

- 1. Safety Protection..... - 3 -
- 2. Brief Instruction..... - 3 -
- 3. Manufacture’ s Authority and Responsibility..... - 3 -
- 4. Parameter Specifications..... - 4 -
- 5. Transport and Storage..... - 5 -
- 6. Installation and Debugging..... - 6 -
- 7. Safety Notices and Precautions..... - 8 -
- 8. Operating Instructions..... - 9 -
- 9. Cleaning and Maintenance..... - 11 -
- 10. Troubleshooting..... - 12 -

1. Safety Protection

⚠ Please make sure that the operator is an authorized and licensed technician before you allow him/her to install and operate the products. Be sure to strictly follow this instruction guide during installation and using. The manufacturer is not responsible for any danger or accidents caused by improper operation or maintenance.

⚠ Do not store flammable or explosive objects around the product. Keep all flammable and explosive objects at a safe distance away from the product for normal using.

⚠ Place the product in a reasonable position. Regarding related matters of gas, customers should execute the requirements of local gas supply sector;

⚠ If you smell a gas leak, turn off the gas valves immediately and call the gas company;

⚠ The product should not be operated by those under 18 years of age, or those with physical or mental disorders, or disabilities that lack the necessary knowledge or experience unless with appropriate instructions and sufficient safety.

2. Brief Instruction

The product is a series of gas griddle in our company production, which is novel designed, reasonable structured, convenient operated, durable used, and convenient maintained. It's equipped with a high efficiency stainless steel tubular burner and a flame out protection device for safe use and ignition device. This is hotel, supermarket, western restaurant, noshery and food industry's ideal grilled product equipment.

3. Manufacture' s Authority and Responsibility

Banning of all or partial transformation to the products without the manufacturer's explicit authorization.

Manufacturers refused to undertake responsibility to third parties as the following reasons:

⚠ Not follow this instruction guidance and warning in using and testing;

⚠ Not in accordance with the requirements of technical parameters using this product;

⚠ Incorrectly or irrationally using the product by untrained personnel;

⚠ Not obey the local law using this product;

⚠ Be repaired or changed by unauthorized technicians;

⚠ Use the spare parts or accessories provided by non-manufacturers;

⚠ Accidents caused by force majeure;

⚠ Not strictly comply with related guide of instruction by any reason.

4. Parameter Specifications

4.1、Outline Dimensions (mm)

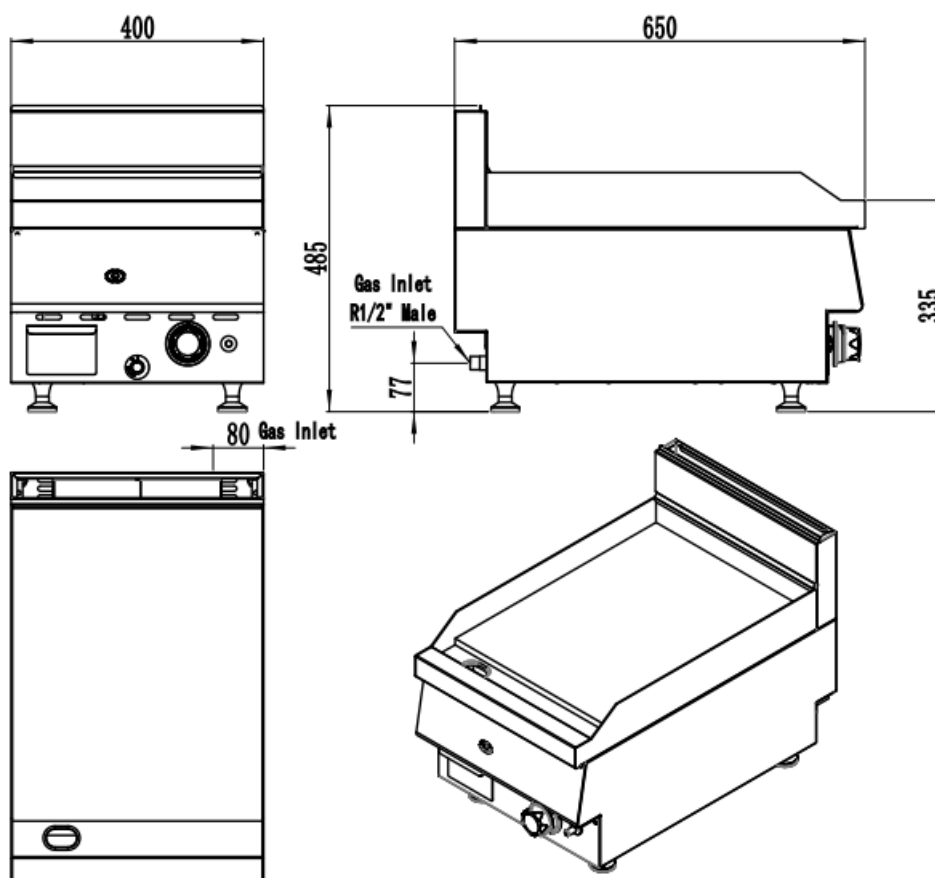

4.2: Size and package parameter information

<Table 1>

Model	Overall dimensions L x W x H	Packing size L x W x H
AT65G4G-C	400*650*485	490*740*620

Gas Connection:

NOTE: ALL GAS FITTING MUST ONLY BE CARRIED OUT BY AN AUTHORISED PERSON.

1. The product do not require an electrical connection, as they function totally on the gas supply only.
2. It is essential that the gas supply is correct for the appliance to be installed and that adequate supply pressure and volume are available. The following checks should therefore be made before installation:

- a. Gas Type required for the appliance is shown in the rating label. Check that this is correct for the gas supply the appliance is being installed for. The gas conversion procedure is detailed in this manual.
- b. Supply Pressure required for this appliance is shown in the 'Gas supply requirements' section of this manual. Check the gas supply to ensure adequate supply pressure exists.
- c. Input Rate of this appliance is stated on the Rating label .The input rate should be checked against the available gas supply line capacity. Particular note should be taken if the appliance is being added to an existing installation.

NOTE: It is important that adequately sized piping runs directly to the connection joint on the appliance with as few tees and elbows as possible to give maximum supply volume.

NOTE: Ensure the regulator is converted to the correct gas type that the appliance will operate on. The regulator outlet pressure is fixed ex-factory for the gas type .

3. Correctly locate the appliance into its final operating position and using a spirit level, adjust the legs so that the unit is level and at the correct height.
4. Connect the gas supply to the appliance through the regulator. A suitable jointing compound which resists the breakdown action of propane must be used on every gas line connection, unless compression fittings are used.
5. Check all gas connections for leakages.
6. Check that the gas operating pressure.
7. Turn off the mains gas supply and bleed the gas out of the appliance gas lines.
8. Turn on the gas supply and the appliance. Verify the operating pressure remains correct.

4.3、Information of Gas Supply and Burner

The minimum supplied gas pressure regulator is factory set at 1.13kPa for Natural Gas and 2.75kPa for L.P. Gas. The external thread of product' s intake-tube is 1/2 inches.

<Table 2>

Model	#of burners and control method	Gas Species	Intake-tube pressure (kPa)	Per Rate MJ/h	Total Rate MJ/h	Nozzle (mm)
AT65G4G-C	1 pieces Independent control	Natural Gas	1.0	25	25	Φ 2.20 (220)
		Propane	2.5	25	25	Φ 1.30 (130)
		ULPG	2.5			

5. Transport and Storage

In the process of transportation, handle carefully and keep upright to prevent damage of the product packing. Wrapped equipment should not be in open air for a long time, and shall be placed in a well-ventilated and non-corrosive gases warehouse. When equipment needs temporary storage, waterproof measures should be taken.

6. Installation and Debugging

⚠ Any erroneous installation, adjustment, refit, overhaul or maintenance may cause property damage or personal injury. The work shall be performed by authorized and licensed technicians, otherwise the manufacturer has the right not to provide warranty service;

⚠ Only be installed in accordance with AS/NZS 5601, the local gas, electricity and other relevant codes. For the latest version of the regulation, please refer to: <https://www.standards.org.au/>

6.1. Unpacking and Installation

⚠ Please dispose of all packaging materials and residues after unpacking;

⚠ Check the equipment. If it is damaged, please keep wrappers and receipts which must be signed by the carrier representative (Driver), and contact the carriers to pursue a claim within 15 days after receiving;

⚠ Be sure to install supporting legs before using, and do not tear up any label or logo before normal using;

⚠ Please read these instructions carefully before installation and operation. Please contact your local agent if you have any questions;

⚠ The equipment shall be installed on a level, solid, non-skid and incombustible surface, and placed in a well-lighted work area with waterproof, and stay away from children and customers;

⚠ The installation position is a well-ventilated place in accordance with the local regulations;

The char broiler must be installed under the matched cooking fume exhauster according to the local regulations;

⚠ **Important: Installation and ventilation laws, and codes are very different, you should state and comply with all codes of the local competent departments when it comes to requirements for installation of equipment;**

⚠ Screw 4 adjustable stainless steel legs in the tapping hole at four corners of the char broiler bottom, ensure sufficient space for ventilation;

⚠ Adjustable stainless steel legs to make the equipment level, and get the same level with other series of the equipment; Please lift the equipment rather than drag if you need to move it;

⚠ Supplied gas pressure regulator is factory set at 1.0kPa for Natural Gas and 2.5kPa for L.P. Gas;

⚠ The equipment can only be placed on the noncombustible floor

⚠ Based on the amendments in relation to AS/NZS 5601.1:2022 refer to below diagram. General installation please refer to official website in Australia.

The regulations within each state may vary.

6.10.2.2 Clearances to a grease filter

The clearance between any part of a grease filter and the nearest part of the cooking surface or *trivet* shall be not less than the clearance specified in [Table 6.10.2.2](#).

Table 6.10.2.2 — Clearances to grease filters

Heat source to grease filters	Appliance	Minimum clearance, mm
Low intensity indirect flame	Kebab cooker, salamander, chicken rotisserie	200 (from top of appliance)
Permanently concealed flame	Solid/flat top griddle/grill plate, deep fryer (top of pan), pasta/noodle cooker, even heat top	600
Naked flame/indirect cooking	Gas hotplate, open burner, stock pot, target top	1050
Intense naked flame where flare/ignition of food typically occurs	Chinese cooking table, wok burner, appliance with user interchangeable or open grill plate (barbecue, broiler – including char, radiant, infrared, automatic and flare types)	1350
Where multiple <i>appliances</i> are serviced by one extraction system, the distance from the cooking surface of each <i>appliance</i> to the grease filter shall be such that the minimum clearance in this Table is applied to each respective <i>appliance</i> .		
NOTE For other commercial catering equipment, refer to the relevant <i>manufacturer's instructions</i> .		

- ⚠ Do not put anything around the equipment, and on the counter top and bottom, in order to avoid influencing combustion and air circulation;
- ⚠ Leave enough distance in front of the equipment to take apart the control panel. All major parts, in addition to the burner remove from the front intake-tube;
- ⚠ It may be necessary to adjust the balance of air input by authorized and licensed technicians;
- ⚠ Thread glue must be resistant to the action of liquefied petroleum gases.
- ⚠ **Warning! Use soap water or testing instrument to test whether piping joint leaks or not before using, and forbid using an open flame to test!**
- ⚠ After installing completely, you should check gas supply pressure. Use a pressure gauge which is equipped with liquid (such as U-type pressure gauge, the minimum value is 0.1mbar) or a digital pressure gauge to test. Steps are as following:

- Remove panel, and needle type pressure joint screw arbor (Fig.1), then slip rubber tube of pressure gauge over needle type pressure joint;
- Start the equipment in accordance with the instructions, measuring gas supply pressure (dynamic pressure) in the work state;
- Access to the equipment if measured data within the limits of Table 2, otherwise, you will need to adjust gas pressure regulating valve or contact gas supplier to bargain;
- Unplug pressure gauge after you accomplish

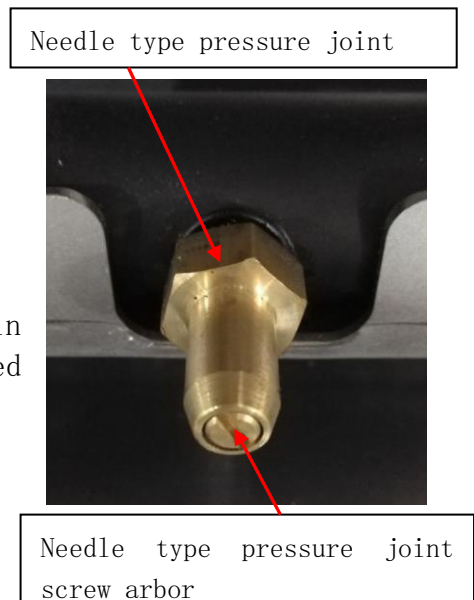

Fig.1

pressure testing, then install needle type pressure joint screw arbor.

Important: make sure screw up the needle valve to prevent gas escape!

⚠ Ensure the pressure and no leaks of the appliance, Check the appliance shall operate normally without flame lift or light back.

⚠ Due to the recent amendments of installation requirements, refer to the Commercial kitchen isolation- clause 5.2.9.2 (bracket AS/NZS 5601.1:2022).

6.2、 Debugging

It's very important to debug the new stove. Through the comprehensive system test of equipment, we can ensure function and safety performance of products. Discovering any potential problems before use (such as equipment's placement, ventilation, operation, etc), can avoid costly losses.

It is necessary to check the machine daily.

Check the machine regularly can avoid serious accident happens.

Stop using if user feels that there are some problems in the circuit or machine.

Check the situation of the machine before or after using every day.

Before using: Whether the machine is tilted?

Whether the control panel is damaged?

During using: Whether there is strange odor or vibration noise?

Whether the burner flame is normal? Any light back or flameout?

Whether the power is normal?

If any of this case occurs, stop using and turn off gas supply, contact the supplier or service department.

7. Safety Notices and Precautions

⚠ **Warning!** For your safety, do not place petrol and other flammables nearby. Please keep clean and free of flammables surroundings.

⚠ **Warning!** Any erroneous installation, adjustment and refit may cause property damage or personal injury and maintenance failure. Read the instructions carefully before installation and using.

⚠ **Warning!** Operation instruction must be placed in a conspicuous location. When customers smell gas in the process of using, you should take safety precautions immediately. Immediately turn off the main gas valve, extinguish all heat and flames. Safety information can be obtained from your local gas suppliers.

⚠ **DO NOT SPRAY AEROSOLS IN THE VICINITY OF THIS APPLIANCE WHILE IT IS IN OPERATION.**

When using this equipment, safety precautions should always

be followed, including the following:

- ⚠ The griddles burners, grates and outside surfaces may become hot after using, so you must be careful to touch;
- ⚠ During operation, do not directly touch burners and plates;
- ⚠ Turn off the equipment as not in using, cleaning, servicing or adjusting any parts or attachments.
- ⚠ If the equipment has any problems of equipment damage, gas piping leaks, igniter or valves damage, or lose product accessories, do not operate by yourself and call for the service immediately;
- ⚠ The attachments not recommended or sold by the manufacturer may cause fire, personal injury, even death;
- ⚠ Do not use out of doors;
- ⚠ The equipment is used for grill, not available for any other using;
- ⚠ The equipment does not contain any user-serviceable parts. Dealers or technicians will repair it. Do not take apart any spare parts without authorization;
- ⚠ Never change any other parts without authorization to this equipment, otherwise, may cause hazards, and the manufacturer has the right not to provide warranty service;
- ⚠ Steel cutting producers used to manufacture with sharp edges. The manufacturer has dealt with these sharp edges during production, however, we insist the operator take care when in contact with this piece of equipment;
- ⚠ Always keep hands, hair and clothing away from heating source.
- ⚠ Wait the unit cools down before you cleaning. Because the unit is too hot to handle after using.

8. Operating Instructions

- ⚠ Before operating, make sure place the unit horizontally by adjusting bottom adjustable legs, and place the catch tray properly.
- ⚠ To ensure that the air flow in the bottom of the equipment .
- ⚠ Do not use a fan or air conditioning to the flame, so as to avoid the flame extinguished and a safety accident.
- ⚠ Must be installed the matched exhaust hood according to the local regulations above the equipment.
- ⚠ To ensure that the air in the kitchen is kept in circulation.
- ⚠ The pilot light has been set at the factory. Each burner has a pilot light.
- ⚠ The minimum temperature of the solid top was about 250°C.

8.1、Lighting the fire



- ①Align the control valve knob on the "0" position (Fig. 2), so that the valve is closed.
- ②And then axial press the front air valve knob, left 30 degrees, to the fire position  (Fig. 3).

③At the fire position, completely press the knob, and press the button of the piezo igniter with another hand simultaneously. Keep pressing the knob about 10-15 seconds, and observe stability of fire.

④If the fire is not lit, please repeat the above steps until the fire is ignited.

Tip: There is air in the pipeline when the first time light the fire, Wait a minute then can normally light the pilot light until flow out air.

8.2、 Igniting the main burner

Revolve the main fire control valve knob anticlockwise after lighting the pilot light, and then the main fire burner is ignited by the pilot light. The power of burner increases as revolving angel increases. When knob reaches to "  " (90 degrees), burner is in the maximum power (Fig.4). Once again axial press the knob and revolve it anticlockwise, the power of burner reduces gradually with the rotation angle increases. When knob is rotated 150 degrees to "  ", burner is working with a minimum power (Fig.5).

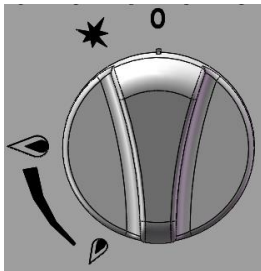

Fig. 2

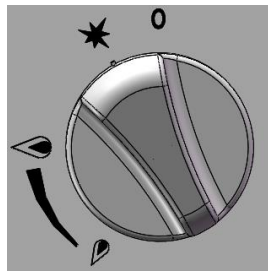

Fig. 3

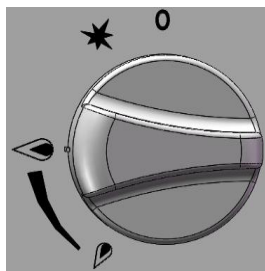

Fig. 4

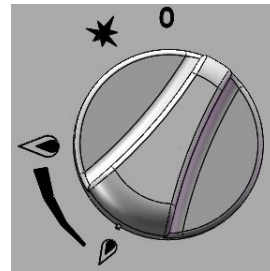



Fig. 5

8.3、 Turn off the valve

①When the control knob is rotated to the fire position  (Fig.3), the main fire burner flame is extinguished, but the pilot light will continue to work.

②Axial press the knob to rotate knob clockwise continually, so that the direction of the knob on the "0" position, at this time, the fire extinguished, the valve closed(Fig.2).

8.4、 Stove Operation

Before using the stove for the first time, please use a mild detergent to wipe it for cleaning. Do not use corrosive or abrasives detergent.

Turn the burners on about 15-20 minutes before broiling for preheating, according to the cooking requirement to adjust the flame size.

Notice: Before first preheating, the furnace will smoke rise. This is because of protective lipids on the grills and other parts are heated, it is normal, and it will be eliminated after the power up to the maximum for burning an hour.

8.5、 Exchange main fire nozzle to switch gas source

Remove the control panel, then remove main fire nozzle with proper open spanner, exchange nozzle of another gas

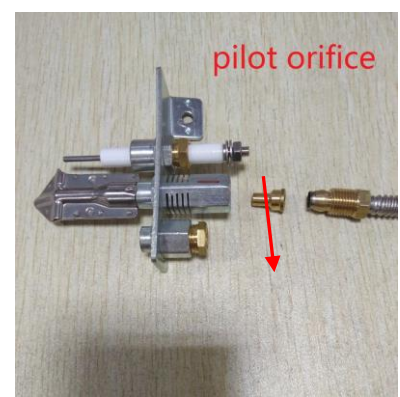

source and the pilot orifice(Fig.6), LPG Pilot orifice(Mark"25"), NG Pilot orifice(Mark"40"), then screw it. Reinstall the cooking grates and the control panel in proper place.

⚠ Caution: Each main fire nozzle of the burner has been installed before delivery, normal use without adjustment but only switching gas. Adjust only by authorized and licensed technicians. When you change the gas source, you need exchange the corresponding pressure maintaining valve and fire seat which installed on air intake. Fig.6

9. Cleaning and Maintenance

⚠ Do not use any abrasive or flammable detergent to wipe;

⚠ Do not hose down, immerse or pressure wash any part of the cooker, excluding the catch tray;

⚠ Do not use abrasive cleaning matters to wash, even not use corrosive detergent!

⚠ The cooking grates cleaning/maintenance:

- (1) when grill cools down, use a cloth with cleaning agent to wipe unit surface and residue;
- (2) use a cloth with water to wipe unit surface;
- (3) burning the main fire burner about 10-20 minutes for sterilization;
- (4) no use for long time, spread cooking oil on grill after cleaning.

⚠ Warning: Before cleaning, all control valves must be turned off. Strictly follow the lighting instructions to work again after cleaning!

⚠ Warning: Wait for the equipment to cool down after the unit has been turned off before you cleaning!

⚠ Cut off the gas source as not in using;

⚠ If the equipment is not used for a long time, clean the surface by wiping it with a soft cloth and place it in a well-ventilated area;

⚠ Comprehensively check the equipment at least once every year by authorized and licensed technicians;

⚠ The product is made of 90% metals, and can not be discarded everywhere. Deal with it in accordance with the local codes.

⚠ Instructions to clean appliance regularly with recommended cleaning agents, if necessary.

Recommended cleaning methods

<Table 2>

Items	Methods	Times
Body	Wipe it with a soft cloth and mild detergent;	daily
Control panel	Turn off valves when not in use; Wipe panel and control valve knob with mild detergent.	daily
Catch tray	Pull out catch tray from front body until the equipment cools down. Clean grease and other crumbs. Reinstall after cleaning. Warning: if the catch tray is permitted to fill too high, should be cleaned!	Per use

10. Troubleshooting

<Table 3>

Problems	Possible causes	Problem solving
Not lighting	1. Insufficient gas pressure in pipe	1. Contact the local gas supply dept.
	2. Nozzle occlusion	2. Dredge nozzle
	3. Thermocouple connection loose	3. Tighten the thermocouple
	4. Thermocouple damage	4. Replace thermocouple
	5. Gas control valve failure	5. Replace gas control valve
Ignite the pilot light but not the main fire	1. Insufficient gas pressure in pipe	1. Contact the local gas supply dept.
	2. The main fire nozzle occlusion	2. Dredge nozzle

	3. Gas control valve failure	3. Replace gas control valves
Close gas and heard a sound of fire	1. Insufficient gas pressure in pipe	1. Contact the local gas supply dept.
	2. Not match nozzle aperture with gas resources	2. Adjust nozzle diameter
	3. Flow of connection pipe is not enough	3. Increase pipe's allowable flow
	4. Damper opening degree is too large	4. Adjust damper
Yellow flame and black smoke	1. Use the gas of bottom	1. Replace gas
	2. Not match nozzle diameter with gas resources	2. Adjust nozzle diameter
	3. Not enough air to ignite	3. Increase damper opening degree
	4. In the peak of using gas, sources of gas float heavy	4. Turn down valves flow. Turn it up after the peak

The problems mentioned above are only for reference. If any fault occurs, please stop using, and contact technicians to check and repair. Safety first, turn off the power and gas supply before maintenance.

Notice:

1、 Pressure maintaining valve connects with air intake must be installed by authorized and licensed technicians to ensure interface tightness.

2、 When the regulator is connected, the maximum load value of natural gas can not exceed 1.13kPa, the maximum value of liquefied gas can not exceed 2.75kPa.

3、 Screw the hex nut (Fig. 7) before connect air intake, ensure gas mark (Fig. 8) on the plastic core match with connected gas source, if not, then pull out the plastic core and change another head, insert it again. The same as exchanging gas source.

NOTICE: Each fire seat has been adjusted before delivery, normal use without adjustment and exchange. Only replace it when converse gas source, and operate by qualified professionals.

4、 The nozzle and pilot orifice in the accessories used in the replacement of the gas resource. Follow rules of 8.5.



Fig. 7



Fig. 8

Our products have the advantages of good durability and low maintenance charge. But to update some components and necessary maintenance, can prolong life length of the products. Contact the dealer for assistance.

For service and spare part inquiry, please contact following
Atosa Catering Equipment Australia Pty Ltd
3-9 Forge Street, Blacktown, Sydney
TEL: 1800 886 888